

INTORQ

POWERED BY KENDRION



INTORQ BFK552

Spring-applied brake with electromagnetic release

Translation of the Original Operating Instructions

www.intorq.com

Document history

Material number	Version			Description
33008750	1.0	08/2020	SC	First edition

Legal regulations

Liability

- The information, data and notes in these Operating Instructions are up to date at the time of printing. Claims referring to drive systems which have already been supplied cannot be derived from this information, illustrations and descriptions.
- We do not accept any liability for damage and operating interference caused by:
 - inappropriate use
 - unauthorized modifications to the product
 - improper work on or with the drive system
 - operating errors
 - disregarding the documentation

Warranty



Notice

The warranty conditions can be found in the terms of sale and delivery from INTORQ GmbH & Co. KG.

- Warranty claims must be made to INTORQ immediately after the defects or faults are detected.
- The warranty is void in all cases when liability claims cannot be made.

Spring-applied brakes of type BFK552

Design size 12



Design size 12 with hand-release



Product key

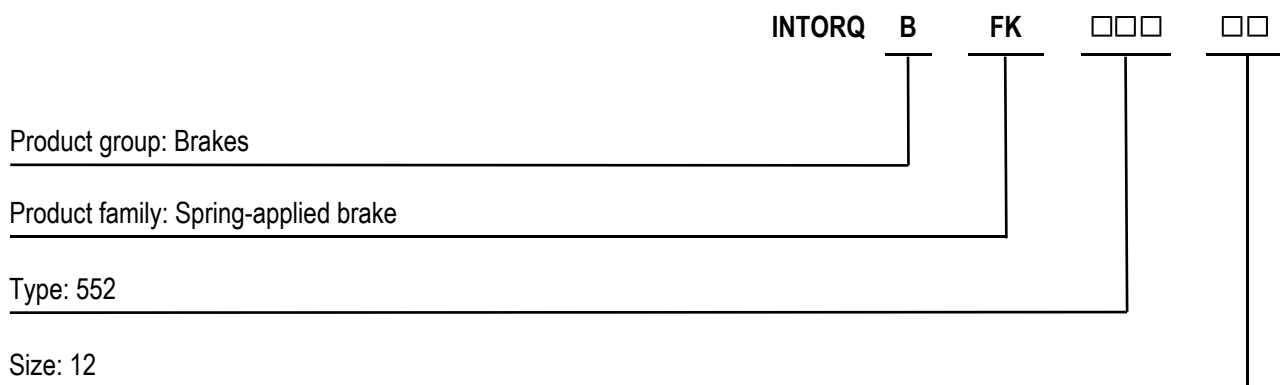

Not coded: Connection voltage, hub bore hole, options

Checking the delivery

After receipt of the delivery, check immediately whether the items delivered match the accompanying papers.

INTORQ does not accept any liability for deficiencies claimed subsequently.

- Claim visible transport damage immediately to the deliverer.
- Claim visible deficiencies or incomplete deliveries immediately to INTORQ GmbH & Co. KG.

Contents

1	General information	6
1.1	Using these Operating Instructions	6
1.2	Conventions in use.....	6
1.3	Safety instructions and notices	6
1.4	Terminology used.....	7
1.5	Abbreviations used.....	8
2	Safety instructions	10
2.1	General safety instructions.....	10
2.2	Disposal	10
3	Product description	11
3.1	Proper and intended usage.....	11
3.1.1	Standard applications	11
3.2	Layout	11
3.2.1	BFK552.....	11
3.3	Function	12
3.4	Braking and release	12
3.5	Project planning notes.....	12
3.6	Variants	12
4	Technical specifications	13
4.1	Possible applications of the INTORQ spring-applied brake	13
4.2	Rated data.....	13
4.3	Switching times	14
4.4	Friction work / operating frequency	16
4.5	Electromagnetic compatibility.....	17
4.6	Emissions.....	17
4.7	Labels on product.....	18

5	Mechanical installation	19
5.1	Design of end shield and shaft.....	19
5.2	Tools	20
5.3	Preparing the installation.....	20
5.4	Installing the hub onto the shaft	21
5.5	Mounting the brake	22
6	Electrical installation	23
6.1	Electrical connection	23
6.1.1	Switching with a DC power supply	24
6.2	Minimum bending radius for the brake connection cable.....	24
7	Commissioning and operation	25
7.1	Possible applications of the INTORQ spring-applied brake	25
7.2	Function checks before initial commissioning	26
7.2.1	Function check of the brake	26
7.2.2	Release / voltage control	26
7.2.3	Testing the hand-release functionality	27
7.3	Commissioning.....	27
7.4	Operation	28
8	Maintenance and repair	29
8.1	Wear of spring-applied brakes	29
8.2	Inspections	30
8.3	Performing functional tests.....	30
8.3.1	Checking the components	30
8.3.2	Checking the air gap.....	30
8.3.3	Release / voltage	31
8.3.4	Brake replacement	31
8.4	Spare parts list	32
9	Troubleshooting and fault elimination	33



1 General information

1.1 Using these Operating Instructions

- These Operating Instructions will help you to work safely with the spring-applied brake with electro-magnetic release. They contain safety instructions that must be followed.
- All persons working on or with electromagnetically released spring-applied brakes must have the Operating Instructions available and observe the information and notes relevant for them.
- The Operating Instructions must always be in a complete and perfectly readable condition.

1.2 Conventions in use



This document uses the following styles to distinguish between different types of information:

Spelling of numbers	Decimal separator	Point	The decimal point is always used. For example: 1234.56
Page reference	Underscore, orange		Reference to another page with additional information For example: <u>Using these Operating Instructions, Page 6</u>
Symbols	Wildcard	□	Wildcard (placeholder) for options or selection details For example: BFK552-□□ = BFK552-10
	Notice		Important notice about ensuring smooth operations or other key information.



1.3 Safety instructions and notices



The following icons and signal words are used in this document to indicate dangers and important safety information:



Structure of safety notices:

	 CAUTION
	<p>Icon Indicates the type of danger</p> <p>Signal word Characterizes the type and severity of danger.</p> <p>Notice text Describes the danger.</p> <p>Possible causes List of possible consequences if the safety notices are disregarded.</p> <p>Protective measures List of protective measures required to avoid the danger.</p>

Danger level

	 DANGER
	<p>DANGER indicates a hazardous situation which, if not avoided, <i>will</i> result in death or serious injury.</p>

	 WARNING
	<p>WARNING indicates a potentially hazardous situation which, if not avoided, <i>could</i> result in death or serious injury.</p>

	 CAUTION
	<p>CAUTION indicates a hazardous situation which, if not avoided, could result in minor or moderate injury.</p>

	NOTICE
	<p>Notice about a harmful situation with possible consequences: the product itself or surrounding objects could be damaged.</p>

1.4 Terminology used

Term	In the following text used for
Spring-applied brake	Spring-applied brake with electromagnetic release
Drive system	Drive systems with spring-applied brakes and other drive components

1.5 Abbreviations used

Letter symbol	Unit	Designation
F_R	N	Rated frictional force
F	N	Spring force
I	A	Current
I_H	A	Holding current, at 20 °C and holding voltage
I_L	A	Release current, at 20 °C and release voltage
I_N	A	Rated current, at 20 °C and rated voltage
M_4	Nm	Torque that can be transmitted without slippage occurring (DIN VDE 0580)
M_A	Nm	Tightening torque of fastening screws
M_{dyn}	Nm	Average torque from initial speed to standstill
M_K	Nm	Rated torque of the brake, rated value at a relative speed of rotation of 100 rpm
n_{max}	rpm	Maximum occurring speed of rotation during the slipping time t_3
P_H	W	Coil power during holding, after voltage change-over and 20 °C
P_L	W	Coil power during release, before voltage change-over and 20 °C
P_N	W	Rated coil power, at rated voltage and 20 °C
Q	J	Quantity of heat/energy
Q_E	J	Max. permissible friction energy for one-time switching, thermal parameter of the brake
Q_R	J	Braking energy, friction energy
Q_{Smax}	J	Maximally permissible friction energy for cyclic switching, depending on the operating frequency
R_N	Ohms	Rated coil resistance at 20 °C
R_z	μm	Averaged surface roughness
S_h	1/h	Operating frequency: the number of switching operations evenly spread over the time unit
S_{hue}	1/h	Transition operating frequency, thermal parameter of the brake
S_{hmax}	1/h	Maximum permissible operating frequency, depending on the friction energy per switching operation
s_L	mm	Air gap: the lift of the armature plate while the brake is switched
s_{LN}	mm	Rated air gap
s_{Lmin}	mm	Minimum air gap
s_{Lmax}	mm	Maximum air gap
t_1	ms	Engagement time, sum of the delay time and braking torque: rise time $t_1 = t_{11} + t_{12}$
t_2	ms	Disengagement time, time from switching the stator until reaching 0.1 M_{dyn}

Letter symbol	Unit	Designation
t_3	ms	Slipping time, operation time of the brake (according to t_{11}) until standstill
t_{11}	ms	Delay during engagement (time from switching off the supply voltage to the beginning of the torque rise)
t_{12}	ms	Rise time of the braking torque, time from the start of torque rise until reaching the braking torque
t_{ue}	s	Over-excitation period
U	V	Voltage
U_H	V DC	Holding voltage, after voltage change-over
U_L	V DC	Release voltage, before voltage change-over
U_N	V DC	Rated coil voltage; in the case of brakes requiring a voltage change-over, U_N equals U_L

2 Safety instructions

2.1 General safety instructions

- Never operate INTORQ components when you notice they are damaged.
- Never make any technical changes to INTORQ components.
- Never operate INTORQ components when they are incompletely mounted or incompletely connected.
- Never operate INTORQ components without their required covers.
- Only use accessories that have been approved by INTORQ.
- Only use original spare parts from the manufacturer.

Keep the following in mind during the initial commissioning and during operation:

- Depending on the degree of protection, INTORQ components may have both live (voltage carrying), moving and rotating parts. Such components require the appropriate safety mechanisms.
- Surfaces can become hot during operation. Take the appropriate safety measures (to ensure contact/touch protection).
- Follow all specifications and information found in the Operating Instructions and the corresponding documentation. These must be followed to maintain safe, trouble-free operations and to achieve the specified product characteristics.
- The installation, maintenance and operation of INTORQ components may only be carried out by qualified personnel. According to IEC 60364 and CENELEC HD 384, skilled personnel must be qualified in the following areas:
 - Familiarity and experience with the installation, assembly, commissioning and operation of the product.
 - Specialist qualifications for the specific field of activity.
 - Skilled personnel must know and apply all regulations for the prevention of accidents, directives, and laws relevant on site.

2.2 Disposal

The INTORQ components are made of various differing materials.

- Recycle metals and plastics.
- Ensure professional disposal of assembled PCBs according to the applicable environmental regulations.

3 Product description

3.1 Proper and intended usage

3.1.1 Standard applications

INTORQ components are intended for use in machinery and facilities. They may only be used for purposes as specified in the order and confirmed by INTORQ. The INTORQ components may only be operated under the conditions specified in these Operating Instructions. They may never be operated beyond their specified performance limits. The technical specifications (refer to [Technical specifications, Page 13](#)) must be followed to comply with the proper and intended usage. Any other usage is consider improper and prohibited.

3.2 Layout

This chapter describes the layout and functionality of INTORQ's BFK552 spring-applied brake.

3.2.1 BFK552

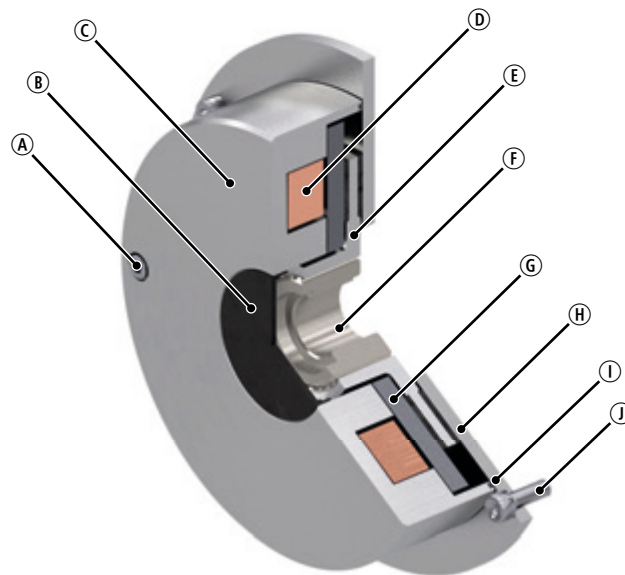

Fig. 1: Layout of an INTORQ BFK552 spring-applied brake (sealed version) + rotor + flange

- | | | |
|--------------------------------|-----------------|----------|
| Ⓐ Emergency hand-release screw | Ⓑ Sealing cover | Ⓒ Stator |
| Ⓓ Coil | Ⓔ Rotor | Ⓕ Hub |
| Ⓖ Armature plate | Ⓗ Flange | Ⓖ Seal |
| Ⓙ Fastening screw | | |

3.3 Function

This brake is an electrically releasable spring-applied brake with a rotating brake disk (rotor) that is equipped on both sides with friction linings. In its de-energized state, the rotor is clamped with braking force applied by pressure springs between the armature plate and a counter friction surface. This corresponds to a fail-safe functionality.

The brake torque applied to the rotor is transferred to the input shaft via a hub that has gear teeth.

The brake can be used as a holding brake and as an emergency stop brake for high speeds.

The asbestos-free friction linings ensure a safe braking torque and low wear.

To release the brake, the armature plate is released electromagnetically from the rotor. The rotor, shifted axially and balanced by the spring force, can rotate freely.

3.4 Braking and release

During the braking procedure, the pressure springs use the armature plate to press the rotor (which can be shifted axially on the hub) against the friction surface. The braking torque is transmitted between the hub and the rotor via gear teeth.

When the brakes are applied, an air gap (s_L) is present between the stator and the armature plate. To release the brake, the coil of the stator is energized with the DC voltage provided. The resulting magnetic flux works against the spring force to draw the armature plate to the stator. This releases the rotor from the spring force and allows it to rotate freely.

3.5 Project planning notes

- When designing a brake for specific applications, torque tolerances, the limiting speeds of the rotors, the thermal resistance of the brake and the effects of environmental influences must all be taken into account.
- The brakes are dimensioned in such a way that the specified rated torques are reached safely after a short run-in process.
- However, as the organic friction linings used do not all have identical properties and because environmental conditions can vary, deviations from the specified braking torques are possible. These must be taken into account in the form of appropriate dimensioning tolerances. Increased breakaway torque is common in particular after long downtimes in humid environments where temperatures vary.
- If the brake is used as a pure holding brake without dynamic load, the friction lining must be reactivated regularly.

3.6 Variants

The BFK552 brake is available in three versions:

- Sealed with emergency hand-release screws
- Unsealed with hand-release shackle
- Unsealed without hand-release shackle

4 Technical specifications

4.1 Possible applications of the INTORQ spring-applied brake

- Degree of protection:
 - The brake is designed for operation under the operating conditions that apply to IP54 protection. Because of the numerous possibilities of using the brake, it is still necessary to check the functionality of all mechanical components under the corresponding operating conditions.
- Ambient temperature:
 - -20 °C to +50 °C (Standard)
 - -30 °C to +50 °C (sealed variant)

4.2 Rated data

Size	Rated brake torque at $\Delta n=100$ rpm	Air gap		Moment of inertia of rotor	Weight of brake	
	M_K	$S_{LN}^{1)}$	$S_{Lmax}^{2)}$	J_{Rotor}	without hand-release	with hand-release
	[Nm]	[mm]	[mm]	[kg cm ²]	[kg]	[kg]
12	60	0.22 ^{+0.15/-0.05}	0.8	4.500	4.7	5

Tab. 1: General data

¹⁾ The default (as delivered) air gap results from the sum tolerances of the individual components.

²⁾ The brake is designed for operating with over-excitation and voltage control. The maximum air gap is reduced when these measures are not available.

Size	Outer diameter	Screw hole circle		Minimum thread depth of motor end shield	Tightening torque
		Diameter (Ø)	Thread		M_A
	[mm]	[mm]		[mm]	[Nm]
12	156 (stator)	168.3	4x M6	13	10.1
	185 (flange)				

Tab. 2: Mounting data

	⚠ CAUTION
	<p>Functional incapacity of the brake</p> <p>It is very important to comply with the minimum thread depth of the end shield (refer to the Mounting data, Page 13 table).</p> <p>If the required thread depth is not maintained, the fastening screws may run onto the thread root. This has the effect that the required pre-load force is not established – the brake is no longer securely fastened!</p> <p>The material of the end shield must have a tensile strength of $R_m > 250$ N/mm² !</p>

Size	Braking torque at $\Delta n_0 =$				Max. rotation speed Δn_0
	100 rpm	1500 rpm	3000 rpm	Max.	^{max}
	[%]	[%]	[%]	[%]	[rpm]
12	100	81	74	73	3600

Tab. 3: Brake torques

Size	Electrical power	Rated voltage	Rated current	Coil resistance
	P_N	U_N	I_N	R_N
	[W]	[V]	[A]	[Ω] $\pm 8\%$
12	84 / 37.3	36 / 24	2.33	15.4
	80 / 45	48 / 36	1.67	28.8

Tab. 4: Coil data

4.3 Switching times

The operating times listed here are guide values which apply to DC switching with rated air gap s_{LN} , warm coil and standard characteristic torque. The operating times given are mean values and subject to variations. The engagement time t_1 is approximately 8 to 10 times longer for AC switching.

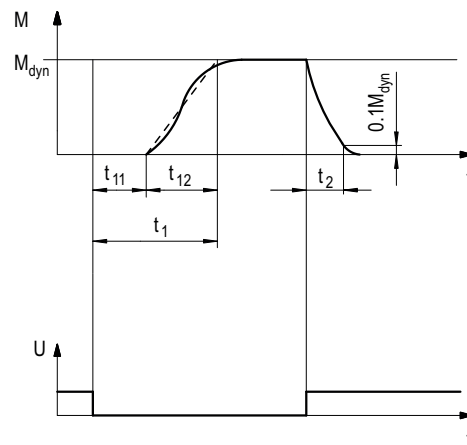

Fig. 2: Operating/switching times of the spring-applied brakes

- | | | | |
|-----------|--|----------|---------------------------------|
| t_1 | Engagement time | t_{11} | Delay time during engagement |
| t_2 | Disengagement time (up to $M = 0.1 M_{dyn}$) | t_{12} | Rise time of the braking torque |
| M_{dyn} | Braking torque at a constant speed of rotation | U | Voltage |

Size	Rated brake torque at $\Delta n=100$ rpm $M_K^{1)}$	$Q_E^{1)}$	S_{hue}	Operating times ²⁾			
				DC-side engagement			Disengaging
				t_{11}	t_{12}	t_1	t_2
	[Nm]	[J]	[1/h]	[ms]	[ms]	[ms]	[ms]
12	60	24000	30	< 30	< 30	< 60	< 110 at $S_{Lmax} = 130$

Tab. 5: Switching energy - operating frequency - operating times

¹⁾ The maximum permissible friction energy Q_E relates to the standard friction lining.

²⁾ The specified operating times refer to a control using holding current reduction and an induction voltage of 300 V at s_{LN} und $0.7 I_N$.

Engagement time

The transition from a brake-torque-free state to a holding-braking torque is not free of time lags.

For emergency braking, short engagement times for the brake are absolutely essential. The DC-side switching in connection with a suitable spark suppressor must therefore be provided.

Engagement time for AC-side switching: The engagement time is significantly longer (approx. 10 times longer).

	NOTICE
	<p>Connect the spark suppressors in parallel to the contact. If this is not admissible for safety reasons (e.g. with hoists and lifts), the spark suppressor can also be connected in parallel to the brake coil.</p>

- If the drive system is operated with a frequency inverter so that the brake will not be de-energized before the motor is at standstill, AC switching is also possible (not applicable to emergency braking).
- The specified engagement times are valid for DC switching with a spark suppressor.

Disengagement time

The disengagement time is the same for DC-side and AC-side switching.

4.4 Friction work / operating frequency

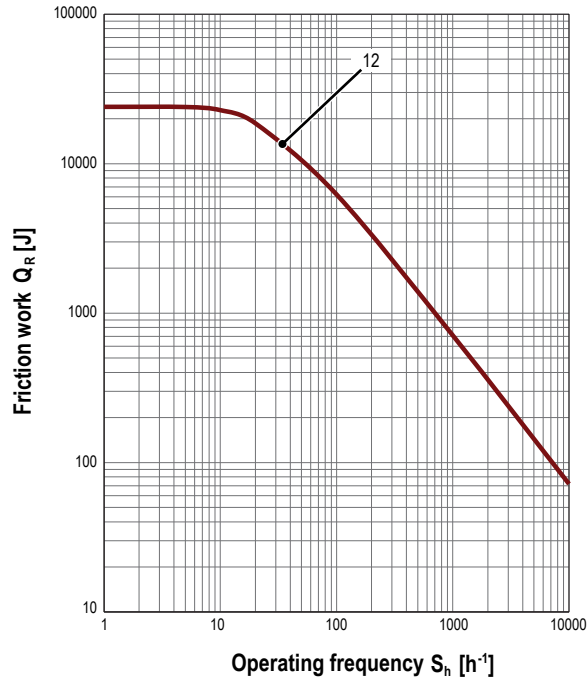

Fig. 3: Friction work as a function of the operating frequency

$$S_{hmax} = \frac{-S_{hue}}{\ln\left(1 - \frac{Q_R}{Q_E}\right)} \qquad Q_{hmax} = Q_E \left(1 - e^{\frac{-S_{hue}}{S_h}}\right)$$

The permissible operating frequency S_{hmax} depends on the friction work Q_R (refer to [Figure Friction work / operating frequency, Page 16](#)). At a pre-set operating frequency S_h , the permissible friction work is Q_{Smax} .



Notice

With high speeds of rotation and switching energy, the wear increases, because very high temperatures occur at the friction surfaces for a short time.

4.5 Electromagnetic compatibility



Notice

The user must ensure compliance with EMC Directive 2014/30/EC using appropriate controls and switching devices.

NOTICE	
	<p>If an INTORQ rectifier is used for the DC switching of the spring-applied brake and if the operating frequency exceeds five switching operations per minute, the use of a mains filter is required.</p> <p>If the spring-applied brake uses a rectifier of another manufacturer for the switching, it may become necessary to connect a spark suppressor in parallel with the AC voltage. Spark suppressors are available on request, depending on the coil voltage.</p>

4.6 Emissions

Heat

Since the brake converts kinetic energy and electrical energy into heat, the surface temperature varies considerably, depending on the operating conditions and possible heat dissipation. A surface temperature of 130 °C may be reached under unfavorable conditions.

Noise

The loudness of the switching noise during engaging and disengaging depends on the air gap "s_L" and the brake size.

Depending on the natural oscillation after installation, operating conditions and the state of the friction surfaces, the brake may squeak during braking.

4.7 Labels on product

There is a packaging label on the package. The name plate is glued to the outer surface of the brake.



Fig. 4: Name plate (example)

INTORQ	Manufacturer
BFK552-12	Type (refer to Product key)
36/24 V DC	Rated voltage (over-excitation / holding voltage)
84 W	Rated power
No. 33008216	ID number
60 NM	Rated torque
22.01.20	Date of manufacture
	CE mark

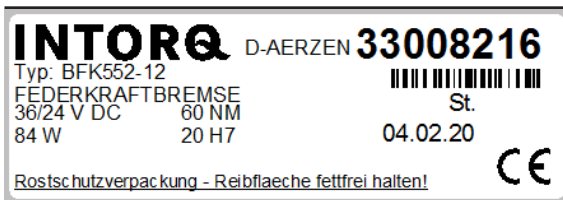





Fig. 5: Packaging label

INTORQ	Manufacturer
33008216	ID number
BFK552-12	Type (refer to Product key)
	Bar code
SPRING-APPLIED BRAKE	Designation of the product family
36/24 V DC	Rated voltage (over-excitation / holding voltage)
60 NM	Rated torque
Pieces	Qty. per box
84 W	Rated power
04.02.20	Packaging date
Anti-rust packaging: keep friction surface free of grease!	Addition
	CE mark

5 Mechanical installation

This chapter provides step-by-step instructions for the installation.

Important notices and information

	NOTICE
	The toothed hub and screws must not be lubricated with grease or oil.

5.1 Design of end shield and shaft

- Comply with the specified minimum requirements regarding the end shield and the shaft to ensure a correct function of the brake.
- The diameter of the shaft shoulder must not be greater than the tooth root diameter of the hub.
- The form and position tolerances apply only to the materials mentioned. Consult with INTORQ before using other materials; INTORQ's written confirmation is required for such usage.
- The brake flange must be supported by the end shield across the full surface.
- Depending on the type of installation, additional clearing bore holes may be required.
- Threaded holes with minimum thread depth: refer to
- Keep the end shield free from grease or oil.



Minimum requirements of the end shield



Size	Material ¹⁾	Run-out	Levelness	Tensile strength R_m
		[mm]	[mm]	[N/mm ²]
12	S235JR; C15; EN-GJL-250	0.05	< 0.06	250

Tab. 6: End shield as counter friction surface

¹⁾ Consult with INTORQ before using other materials.

5.2 Tools

Size	Torque wrench	Insert for hexagonal socket (Allen) screws
		
	Measuring range [Nm]	Wrench width
12	1 to 12	5 mm hexagon socket, 40 mm length

Multimeter	Caliper gage	Feeler gage
		

	NOTICE
	Tightening torques: refer to the installation data table in the chapter <u>Mounting data</u> , Page 13.

5.3 Preparing the installation

1. Remove the packaging from the spring-applied brake and dispose of it properly.
2. Check the delivery for completeness.
3. Check the name plate specifications (especially rated voltage)!

5.4 Installing the hub onto the shaft



Notice

The customer is responsible for dimensioning the shaft-hub connection. Make sure that the length of the key (shape A) is identical to the length of the hub.

- Tensile strength of the hub material:
 - Size 12: Tensile strength $R_m > 460 \text{ N/mm}^2$

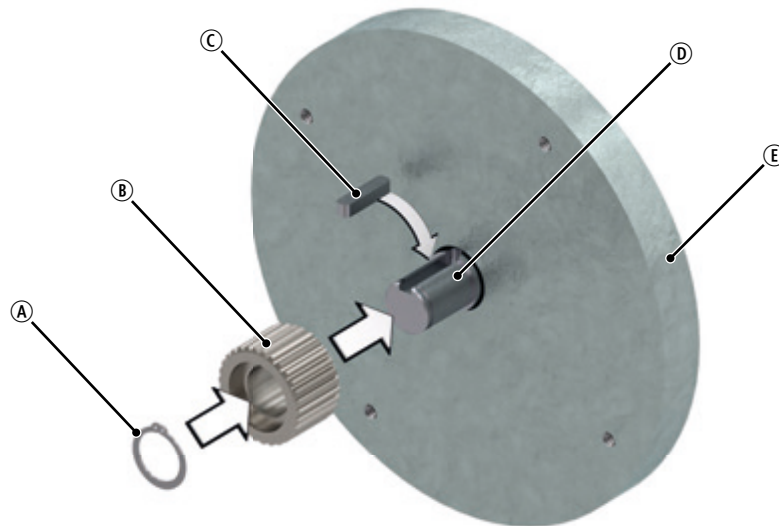

Fig. 6: Mounting the hub

- | | | |
|-----------|--------------|-------|
| Ⓐ Circlip | Ⓑ Hub | Ⓒ Key |
| Ⓓ Shaft | Ⓔ End shield | |

1. Insert the key into the shaft.
2. Press the hub with a moderate amount of force to the shaft.
3. Secure the hub against axial displacement (for example, by using a circlip).



NOTICE

If you are using the spring-applied brake for reverse operations, glue the hub to the shaft.

5.5 Mounting the brake

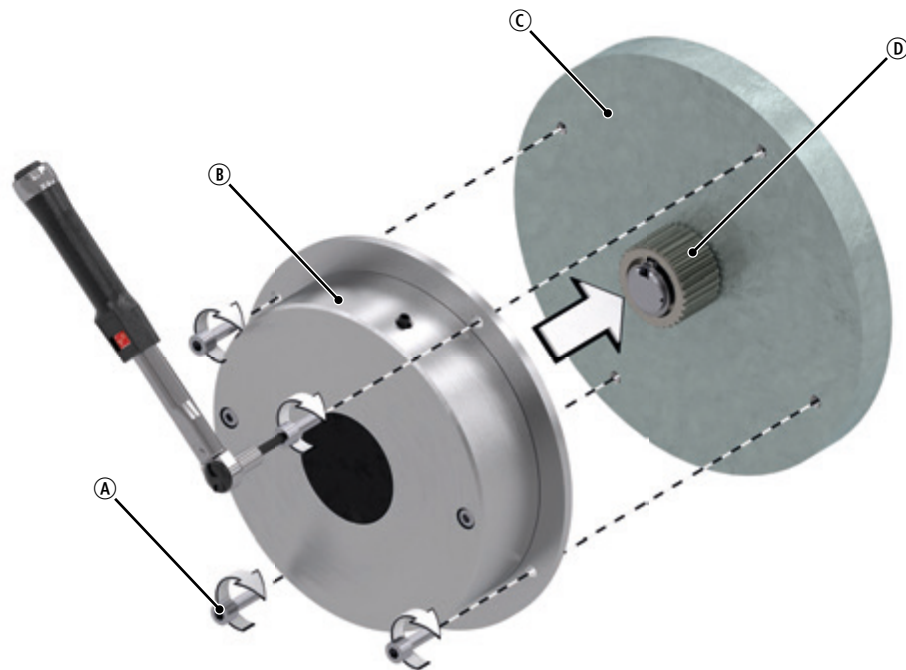



Fig. 7: Mounting the brake

- Ⓐ Fastening screw Ⓑ Spring-applied brake Ⓒ End shield
Ⓓ Hub

1. Push the spring-applied brake on the hub.
2. Screw the spring-applied brake to the end shield using the specified cap screws. Use a torque wrench (refer to the [Mounting data, Page 13](#) table for the tightening torques).
3. Remove the two emergency hand-release screws from the brake.

6 Electrical installation

Important notes

	 DANGER
	<p>There is a risk of injury by electrical shock!</p> <ul style="list-style-type: none">■ The electrical connections may only be made by trained electricians!■ Make sure that you switch off the electricity before working on the connections! There is a risk of unintended start-ups or electric shock.

	NOTICE
	Make sure that the supply voltage matches the voltage specification on the name plate.

6.1 Electrical connection

	NOTICE
	The brake is designed to be controlled with automatic holding current reduction. The holding current reduction must be between 1.5 and 2 s.

Connect the two cables of the brake to a DC voltage source. Over-excitation may only occur in the first 1.5 – 2 seconds. The holding voltage should then be lowered.

The polarity of the brake connection can be selected by the user; it has no influence on the functionality of the brake.

6.1.1 Switching with a DC power supply

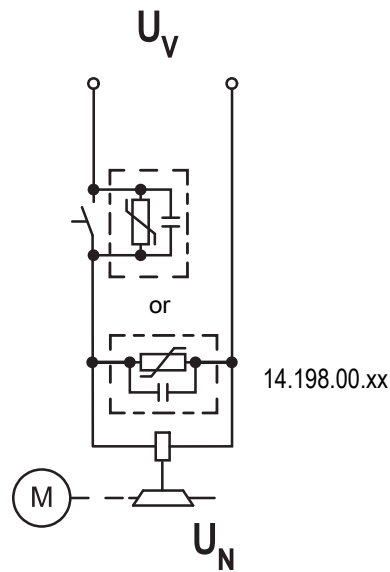

Fig. 8: DC power supply



Notice

Spark suppressor: 14.198.00.xx (required once, select position)

6.2 Minimum bending radius for the brake connection cable

Size	Wire cross-section	Minimum bending radius
12	AWG 20	6 mm

Tab. 7: Minimum bending radius for the brake connection cable

7 Commissioning and operation

7.1 Possible applications of the INTORQ spring-applied brake

	NOTICE
	<p>In case of high humidity: If condensed water and moisture are present, provide for the appropriate ventilation for the brake to ensure that all friction components dry quickly.</p> <p>At high humidity and low temperatures: Take measures to ensure that the armature plate and rotor do not freeze.</p>

Important notes

	⚠ DANGER
	<p>Danger: rotating parts!</p> <ul style="list-style-type: none"> ■ The brake must be free of residual torque. ■ The drive must not be running when checking the brake.

	⚠ DANGER
	<p>There is a risk of injury by electrical shock!</p> <p>The live connections must not be touched.</p>

- The brake is designed for operation under the environmental conditions that apply to IP54 protection. Because of the numerous possibilities of using the brake, it is still necessary to check the functionality of all mechanical components under the corresponding operating conditions.



Notice

Functionality for different operating conditions

- The brakes are dimensioned in such a way that the specified rated torques are reached safely after a short run-in process.
- However, as the organic friction linings used do not all have identical properties and because environmental conditions can vary, deviations from the specified braking torques are possible. These must be taken into account in the form of appropriate dimensioning tolerances. Increased breakaway torque is common, in particular after long downtimes in humid environments where temperatures vary.







Notice

Operation without dynamic loads (functioning as a pure holding brake)

- If the brake is used as a pure holding brake without dynamic load, the friction lining must be reactivated regularly.

7.2 Function checks before initial commissioning

	 DANGER
	<p>Danger: rotating parts!</p> <ul style="list-style-type: none"> ■ The brake must be free of residual torque. ■ The drive must not be running when checking the brake.



	 DANGER
	<p>There is a risk of injury by electrical shock!</p> <p>The live connections must not be touched.</p>

7.2.1 Function check of the brake

If a fault or malfunction arises during the function check, you can find important information for troubleshooting in the chapter Troubleshooting and fault elimination. If the fault cannot be fixed or eliminated, please contact the customer service department.

7.2.2 Release / voltage control

1. Switch off the supply to the motor and brake securely.
2. When switching on the brake supply, make sure that the motor DOES NOT start up (e.g. remove the two bridges on the motor terminals).
 - **Do not** disconnect the supply connections to the brake.

	 DANGER
	<p>Danger: rotating parts!</p> <p>Your system should be mechanically immobilized in the event that it could start moving when the brake is released.</p>

3. Switch the power on.
4. Measure the DC voltage at the brake.
 - Compare the measured voltage to the voltage specified on the name plate. A deviation of up to 10% is permitted.
5. Check the air gap S_L . The air gap must be zero and the rotor must rotate freely.
6. Switch off the supply to the motor and brake securely.
7. Connect the bridges to the motor terminals.

7.2.3 Testing the hand-release functionality

	NOTICE
	This operational test must also be carried out!

1. Make sure that the motor and brake are de-energized.
2. Pull (with some force) on the lever until the force increases sharply.
 - The rotor must now rotate freely. A small residual torque is permissible.

	NOTICE
	<ul style="list-style-type: none"> ■ Make sure that the brake is not subject to excessive force. ■ Do not use auxiliary tools (e.g. extension pipes) to facilitate the air release. Auxiliary tools are not permitted and are not considered as proper and intended usage.

3. Release the lever.
 - A sufficient torque must build up immediately!



Notice

If faults occur, refer to the error search table (Troubleshooting and fault elimination). If the fault cannot be fixed or eliminated, please contact the customer service department.

7.3 Commissioning

	⚠ DANGER
	<p>Danger: rotating parts!</p> <ul style="list-style-type: none"> ■ The brake must be free of residual torque. ■ The drive must not be running when checking the brake.

	⚠ DANGER
	<p>There is a risk of injury by electrical shock!</p> <p>The live connections must not be touched.</p>

1. Switch on your drive system.
2. Perform a test braking procedure; if necessary, reduce the braking torque (depending on your specifications and requirements)

7.4 Operation



	⚠ DANGER
	Danger: rotating parts! <ul style="list-style-type: none">■ The running rotor must not be touched.■ Take structural design measures on your final product and implement organizational safety rules to ensure that nobody can touch a rotor.

	⚠ DANGER
	There is a risk of injury by electrical shock! <ul style="list-style-type: none">■ Live connections must not be touched.■ Take structural design measures on your final product and implement organizational safety rules to ensure that nobody can touch a connection.

- Checks must be carried out regularly. Pay special attention to:
 - unusual noises or temperatures
 - loose fixing/attachment elements
 - the condition of the electrical cables.
- While current is being applied to the brake, make sure that the armature plate is completely tightened and the drive moves without residual torque.
- Measure the DC voltage at the brake. Compare the measured DC voltage with the voltage indicated on the name plate. The deviation must be less than $\pm 10\%$!

8 Maintenance and repair

8.1 Wear of spring-applied brakes

	 WARNING
	<p>Braking torque reduction</p> <p>The system must not be allowed to continue operations after the maximum air gap s_{Lmax} has been exceeded. Exceeding the maximum air gap can cause a major reduction in the braking torque!</p>

The table below shows the different causes of wear and their impact on the components of the spring-applied brake. The influential factors must be quantified so that the service life of the rotor and brake can be calculated and so that the prescribed maintenance intervals can be specified accurately. The most important factors in this context are the applied friction work, the initial speed of rotation of braking and the operating frequency. If several of the causes of friction lining wear occur in an application at the same time, the effects should be added together when the amount of wear is calculated.

Component	Cause	Effect	Influencing factors
Rotor	Braking during operation	Wear of the friction lining	Friction work
	Emergency stops		
	Overlapping wear during start and stop of drive		
	Active braking via the drive motor with support of brake (quick stop)		Number of start/stop cycles
	Starting wear in case of motor mounting position with vertical shaft, even when the brake is not applied		
Armature plate and counter friction surface	Rubbing and friction of the brake lining	Run-in of armature plate and counter friction surface	Friction work
Gear teeth of brake rotor	Relative movements and shocks between brake rotor and brake shaft	Wear of gear teeth (primarily on the rotor side)	Number of start/stop cycles
Armature plate support	Load reversals and jerks in the backlash between armature plate, adjustment tubes and guide/cylinder pins	Breaking of armature plate, sleeve bolts and bolts or cylinder pins	Number of start/stop cycles, braking torque
Springs	Axial load cycle and shear stress of springs through radial backlash on reversal of armature plate	Reduced spring force or fatigue failure	Number of switching operations of brake

Tab. 8: Causes for wear

8.2 Inspections

To ensure safe and trouble-free operations, the spring-applied brakes must be checked at regular intervals. Servicing at the facility will be easier if the brakes are made accessible. This must be considered when installing the drives in the plant.

This brake requires no maintenance. We recommend that you do not replace any components. No maintenance is required.

8.3 Performing functional tests

8.3.1 Checking the components

With mounted brake	■ Check release function and control	Refer to Release / voltage, Page 31
---------------------------	--------------------------------------	---

8.3.2 Checking the air gap



Notice

It is possible and useful to check the air gap only for the version with hand-release and for the unsealed version.

	⚠ DANGER
	Danger: rotating parts! The motor must not run while the air gap is being checked.

1. Measure the air gap s_L between the armature plate and the rotor near the fastening screws using a feeler gage in the opening provided (for the version with hand-release). (Refer to the values in table [General data, Page 13.](#))
2. Compare the measured air gap to the value for the max. permissible air gap s_{Lmax} . (Refer to the [General data, Page 13](#) table for the values.)
3. Replace the complete brake when the maximum air gap has been reached.

8.3.3 Release / voltage

	⚠ DANGER
	<p>Danger: rotating parts! The running rotor must not be touched.</p>

	⚠ DANGER
	<p>There is a risk of injury by electrical shock! The live connections must not be touched.</p>

1. Check the brake functionality when the drive is running: The armature plate must be tightened and the rotor must move without residual torque.
2. Measure the DC voltage at the brake.
3. Compare the measured voltage to the voltage specified on the name plate. A deviation of up to 10% is permitted.

8.3.4 Brake replacement

	⚠ DANGER
	<p>Danger: rotating parts! Switch off the voltage. The brake must be free of residual torque. Your system should be mechanically immobilized in the event that it could start moving when the brake is released.</p>

1. Remove the connection cables.
2. Loosen the screws evenly and then remove them.
3. Pay attention to the connection cable during this step! Remove the complete brake from the end shield.
4. Pull the brake off the hub.
5. Replace the hub.
6. Check the function of the brake as described in the [Release / voltage, Page 31](#) section. Mount a new brake if necessary.
7. Reconnect the connection cable and put the brake back into operations.
8. If necessary, deactivate the mechanical shutdown of the system.

8.4 Spare parts list

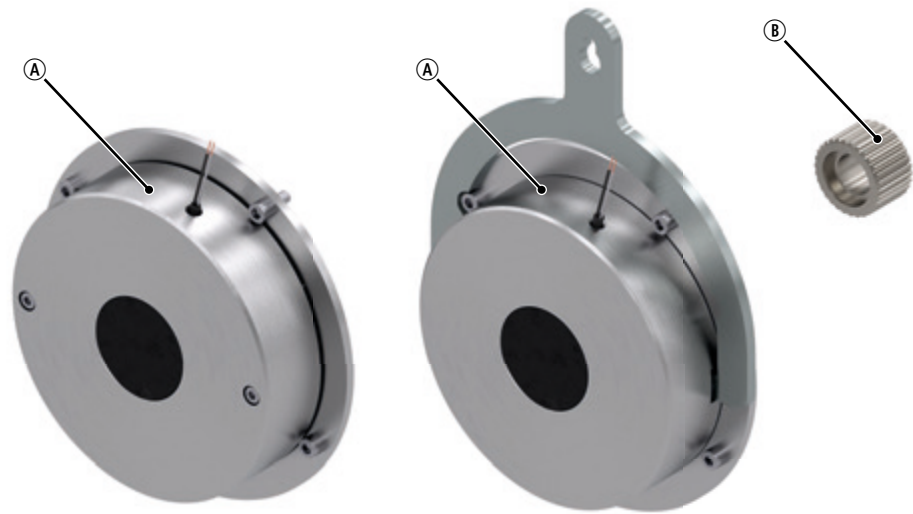

Fig. 9: INTORQ BFK552 spring-applied brake

	Designation	Variant
Ⓐ	Brake / Brake with hand-release	<ul style="list-style-type: none"> ■ Size ■ Voltage ■ Brake torque ■ Hand-release
Ⓑ	Hub	<ul style="list-style-type: none"> ■ Size

9 Troubleshooting and fault elimination

If any malfunctions should occur during operations, please check for possible causes based on the following table. If the fault cannot be fixed or eliminated by one of the listed steps, please contact customer service.

Fault	Cause	Remedy
Brake cannot be released, air gap is not zero	Coil interruption	<ul style="list-style-type: none"> ■ Measure coil resistance using a multimeter: <ul style="list-style-type: none"> – If resistance is too high, replace the complete spring-applied brake.
	Coil has contact to earth or between windings	<ul style="list-style-type: none"> ■ Measure coil resistance using a multimeter: <ul style="list-style-type: none"> – Compare the measured resistance with the nominal resistance. Refer to for the values. If resistance is too low, replace the complete stator. ■ Check the coil for short to ground using a multimeter: <ul style="list-style-type: none"> – If there is a short to ground, replace the complete spring-applied brake. ■ Check the brake voltage (refer to section on defective rectifier, voltage too low).
	Wiring defective or wrong	<ul style="list-style-type: none"> ■ Check the wiring and correct. ■ Check the cable for continuity using a multimeter <ul style="list-style-type: none"> – Replace a defective cable.
	Air gap too big	<ul style="list-style-type: none"> ■ For the spring-applied brake INTORQ BFK457-06 ... 16: replace the basic rotor. ■ For the INTORQ BFK457-06 ... 16 Compact spring-applied brake: replace the complete brake.

 INTORQ GmbH & Co KG
Germany
PO Box 1103
D-31849 Aerzen, Germany
Wülmser Weg 5
D-31855 Aerzen, Germany
 +49 5154 70534-0 (Headquarters)
 +49 5154 70534-222 (Sales)
 +49 5154 70534-200
 info@intorq.com

 应拓柯制动器 (上海) 有限责任公司
INTORQ (Shanghai) Co., Ltd.
上海市浦东新区泥城镇新元南路600
号6号楼一楼B座
No. 600, Xin Yuan Nan Road,
Building No. 6 / Zone B
Nicheng town, Pudong
201306 Shanghai
 +86 21 20363-810
 +86 21 20363-805
 info@cn.intorq.com

 INTORQ US Inc.
USA
300 Lake Ridge Drive SE
Smyrna, GA 30082, USA
 +1 678 236-0555
 +1 678 309-1157
 info@us.intorq.com

 INTORQ India Private Limited
India
Plot No E-2/7
Chakan Industrial Area, Phase 3
Kharabwadi, Taluka – Khed
Pune, 410501, Maharashtra
 +91 2135625500
 info@intorq.in